

ASSEMBLY MANUAL

PLWH01 Pro Line Desk White
PLBL01 Pro Line Desk Black
PLALLWH01 Pro Line Desk all White
PLALLBL01 Pro Line Desk all Black

! NOTE: In order to avoid injury or damages, please do not try to assemble your desk alone. PRO - Line is a heavy desk, which requires at least two people to carry out assembly. Please assemble on soft surface to avoid scratches to the lacquer.

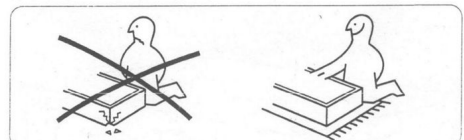
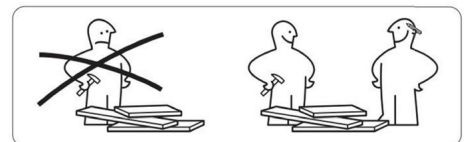

Thank you for making StudioDesk your desk of choice!

Before beginning assembly of your desk, let's get familiar with the parts you have received in your package. Please match the corresponding numbers on this page with the drawings.





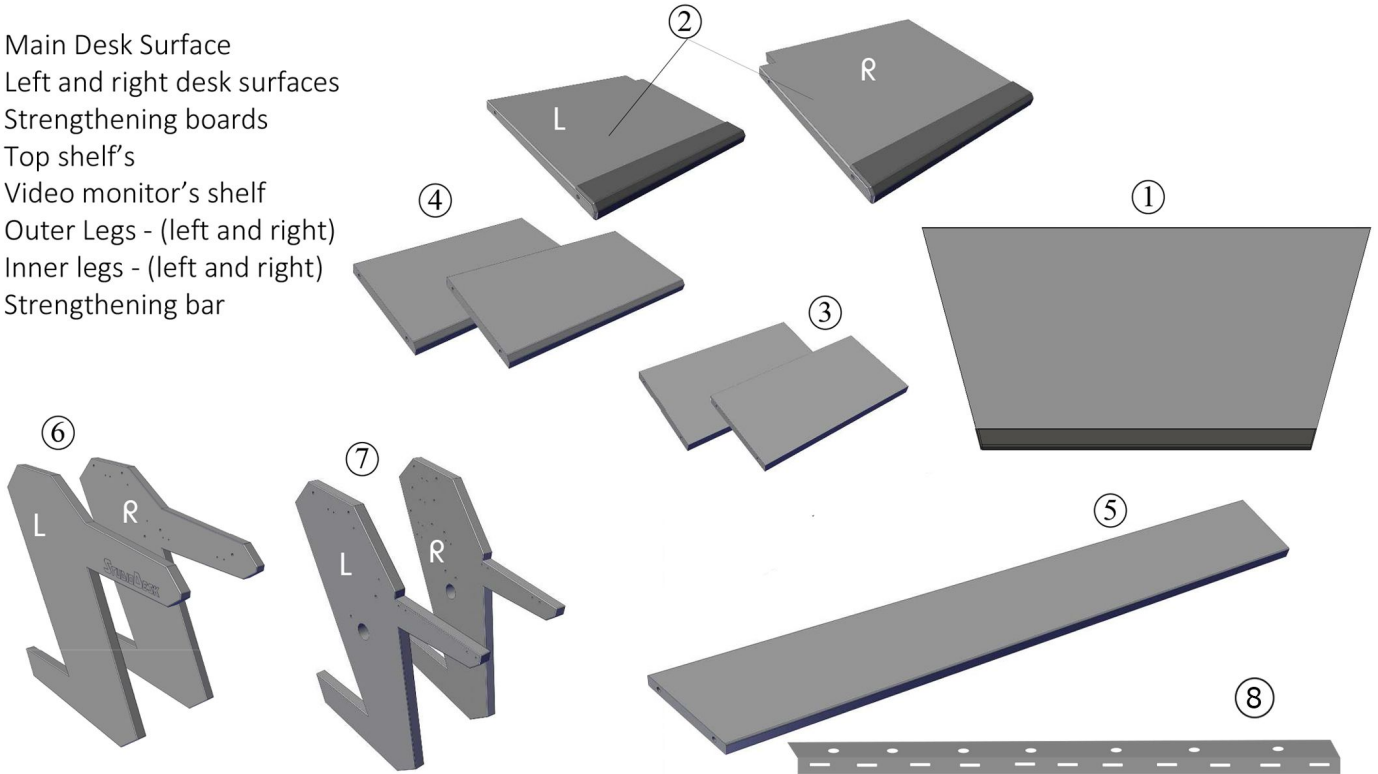



Wooden parts

1. Main Desk Surface
2. Left and right desk surfaces
3. Strengthening boards
4. Top shelf's
5. Video monitor's shelf
6. Outer Legs - (left and right)
7. Inner legs - (left and right)
8. Strengthening bar

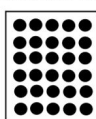

Hardware

Tools needed (Not included)

<p>⑨ Metal corner 20 pcs</p> 	<p>⑫ M6 Screws for Rack rails 4 pcs</p> 	<p>⑰ Stickers to cover inserts not in use</p> 
<p>⑩ Desk tips 8 pcs</p> 	<p>⑬ Wooden Dowels 34 pcs</p> 	<p>⑯ Cable inlays for Legs 2 pcs</p> 
<p>⑪ M6 Screw 90 pcs</p> 	<p>⑭ Rack rails 5 U 4 pcs</p> 	<p>⑮ Washers 7 pcs</p> 

Rubber hammer



Phillips Screwdriver

1 Step One

Insert dowels (13) into the holes as shown in the illustration. Use a rubber hammer if needed.

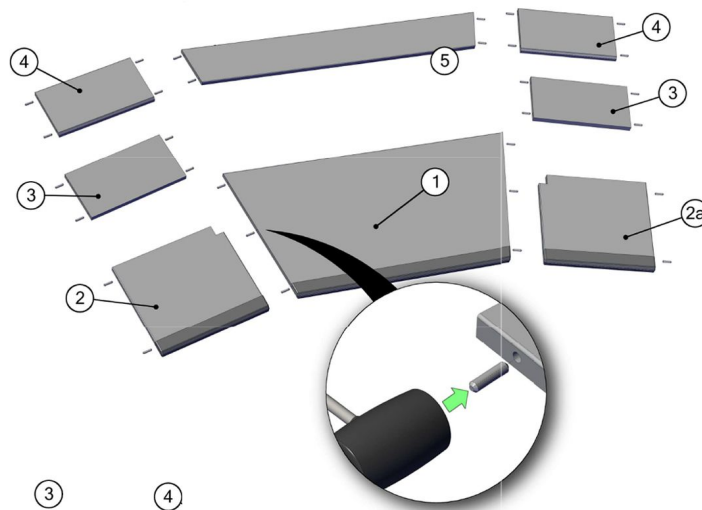

2 Step Two

Assemble parts together on dowels as shown in the illustration.

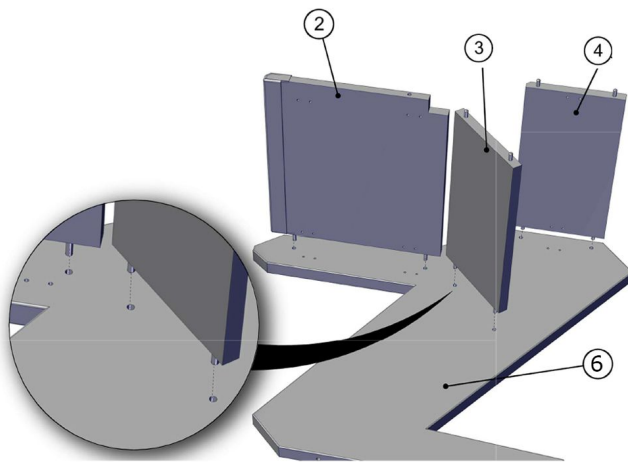

3 Step Three

Fix assembled parts together using metal corners (9) and M6 screws (11) as shown in the illustration.

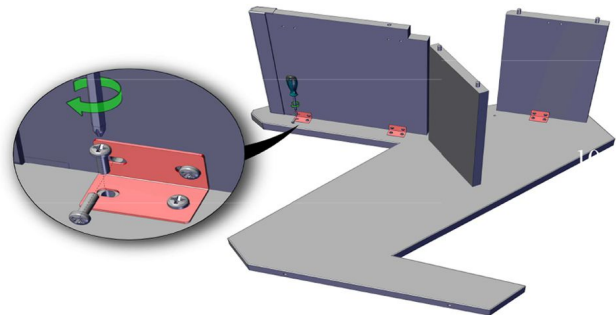

4 Step Four

Place inner leg to assembled section onto the corresponding holes on the leg. Take special care to avoid scratching the lacquered surface. Push the Inner leg down until the dowels seat properly in their respective holes. Use a rubber hammer, if needed. Usually it is not necessary.

5 Step Five

Once dowels are in place and boards sit tight to the leg, use metal corners (9) and M6 screws (11) to fix the middle section to the leg. Repeat procedure with right Module. Note! Turn the metal corner's shorter edge downward

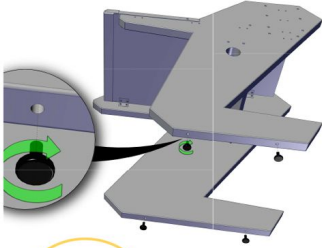
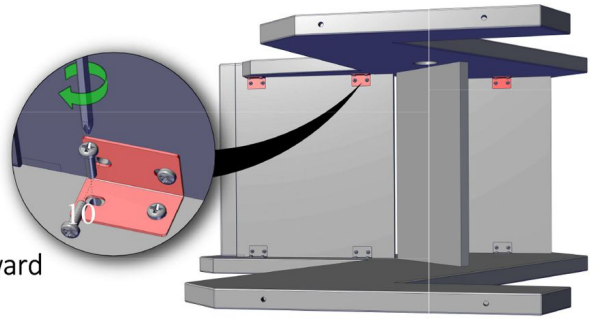

6

Step Six

Screw the desk tips to the legs on both left and right module.

7

Step Seven

Please read appendix manual in this step. Turn modules on it's standing position and position them on proximity of the length of the main desk surface.

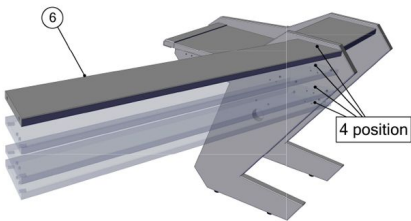
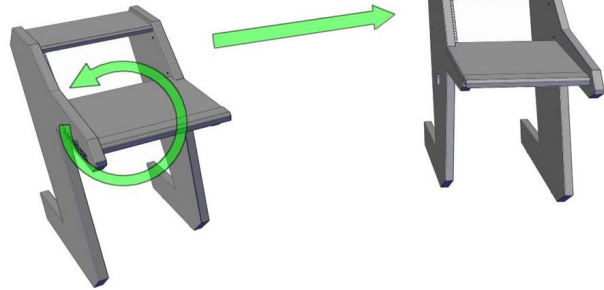

8

Step Eight

Decide on which position you are going to have your video monitor shelf. There is 4 positions to chose from. Install strengthening bar to the bottom of the video monitor shelf using M6 Screws and washers.

9

Step Nine

Connect two modules with middle parts one by one shown on the illustration. Desk will stand freely on dowels. Push the modules closer until the dowels seat properly in their respective holes in legs and and desk surfaces are tight to each other.

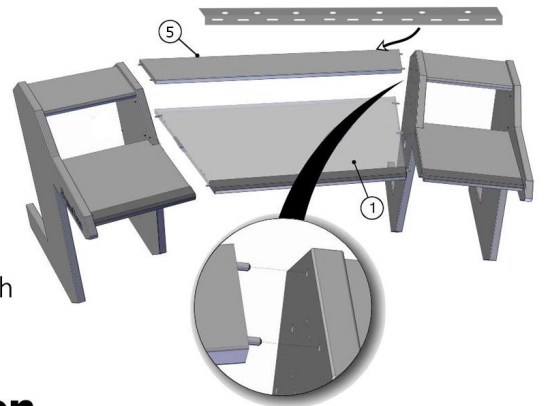

10

Step Ten

Fix middle section to the legs using metal corners (9) and M6 screws (11)

Note! Turn the metal corner's shorter edge downward

Fix rack rails (14) to the legs using M6 screws (12). Positions for the screws are predefined.

